

EXPERIMENTAL STUDY OF LOCAL SCOUR DOWNSTREAM STILLING BASINS

By El-Gamal, M. M.¹, Ragih, O. S.², Sobeih, M. M. F.³
and El Abd S. M.⁴

^{1,2 and 4}Irrig., and Hydr. Dept., Faculty of Engineering, El-Mansoura University.

³Civil Engineering Dept., Faculty of Engineering, Minufiya University.

دراسة معملية للنحر المحلي خلف أحواض التهدئة

خلاصة:

يقدم هذا البحث دراسة معملية تجريبية لظاهرة النحر المحلي خلف منشآت الري مع الأخذ في الاعتبار تأثير أحواض التهدئة على شكل بيارة النحر. هذا وقد أجريت التجارب على القناة المعملية بكلية الهندسة - جامعة المنصورة، حيث تم إجراء حوالي ٣٣٠ تجربة لدراسة تأثير المتغيرات المختلفة مثل أبعاد أحواض التهدئة، فتحة البوابة معدل السريان، السرعة، عمق المياه، نوع التربة على أبعاد حفرة النحر. يشمل هذا البحث أيضا تحليل النتائج المعملية من خلال العلاقات الترابطية بالنحر كدالة في المتغيرات المختلفة وذلك باستخدام نظرية التحليل البعدي. وقد أظهرت النتائج توافقا جيدا بين المتغيرات المختلفة، حيث تم استنباط معادلات تجريبية يمكن استخدامها تطبيقيا للتنبؤ بأبعاد حفرة النحر في الحالات المشابهة لحالة الدراسة.

ABSTRACT

The effect of using stilling basins on local scour phenomena, which occur downstream irrigation structures, was conducted out in the laboratory of irrigation and hydraulics, Faculty of engineering – El-Mansoura University.

Experiments were carried out for different gate openings, flow conditions, and dimensions of stilling basins, using two types of sand as bed material. This research was performed for Froude number ranged from 0.26 to 0.45 for selected dimensionless relationships between the design parameters.

Empirical relationships between the dimensions of stilling basins, flow conditions, bed material and scour hole parameters were developed from dimensional analysis technique based on the data obtained from the experimental tests.

Generally, the obtained results showed good fitting between the different parameters. The results indicated that the dimensions of the scour hole were affected by Froude number downstream the sluice gate.

INTRODUCTION

Local scour is considered one of the tedious and complicated problems facing variety of irrigation works, such as dams, barrages, and weirs, etc., which are built crossing the flow of large alluvial rivers. Local scour downstream irrigation works may undermine these structures. Therefore, it is important to determine the value of

maximum scour depth downstream irrigation structure to protect it from failure. A lot of research have been carried out on the process of the hydraulic jump as an energy dissipation [2, 8] besides other means to enhance the behavior of the hydraulic jump with in the basin [5]. However, there is considerable uncertainty in how well the basins will perform if the conditions are different from those assumed or computed. Scour downstream irrigation structures has been investigated by many researchers [4, 1, 6, 11] Also many formulas for scour following hydraulic jump in a stilling basin were developed [7, 3, 9, 10].

In this research , the local scour follows stilling basins downstream irrigation structures were considered. Measurements for the dimensions were made of the scour hole for different flow depths, and discharges.

EXPERIMENTAL ARRANGEMENT

The experiments were conducted in a Plexiglass flume 4.80 m long, 0.075 m wide, and 0.17 m deep, of a circulating type, Fig. (1). Five different stilling basin models, each model had a length varied between 5.0 cm and 25.0 cm, and a depth varied between 0.50 cm and 2.0 cm below the fixed bed. Fig. (2) shows the dimensions and geometry of the stilling basins used in the experiments. The stilling basins used in the experiments were divided into 30 types according to its length and depth as shown in table (1). The characteristics of the two types of bed material used in The experiments are listed in table (2).

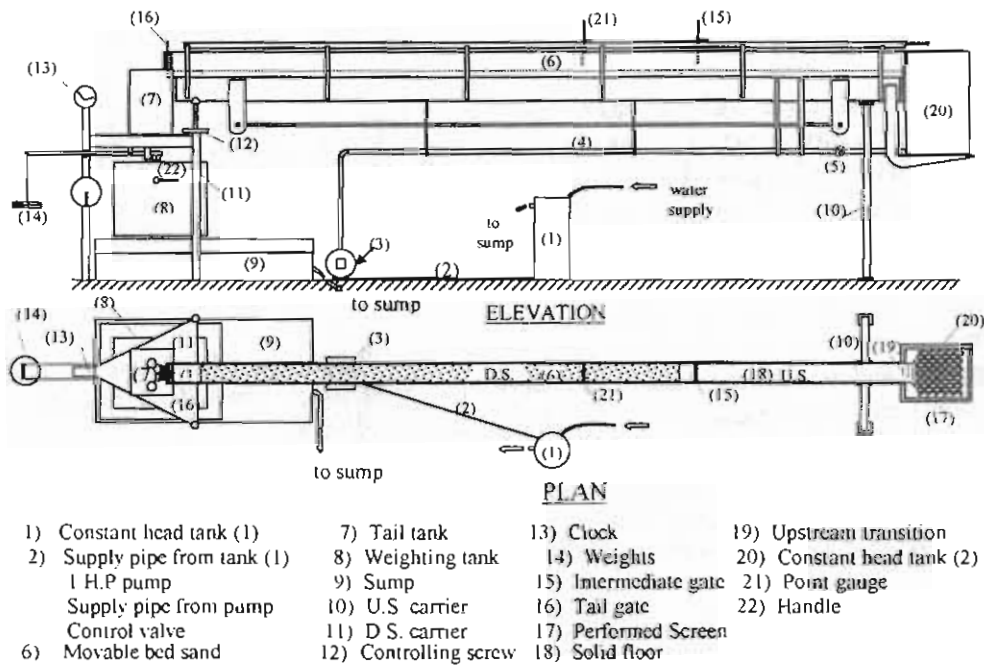

Fig. (1) General arrangement of the experimental setup

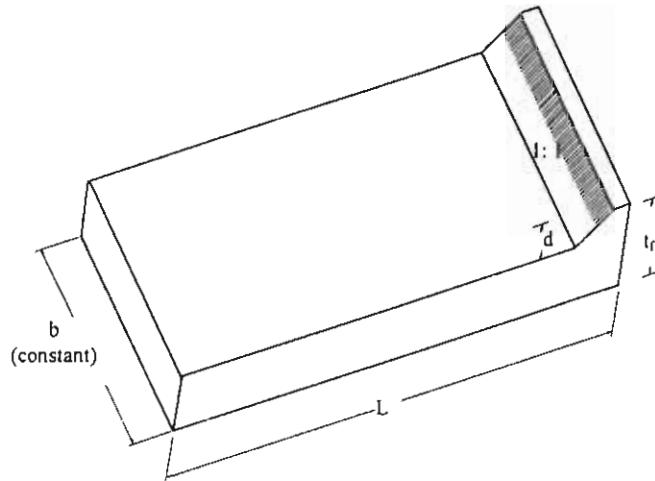

Fig. (2) Definition Sketch for the main dimensions of the tested Stilling Basin

Table (1) List of the various types used for the Hypothetical Stilling Basins

Dimension Types	L	d	L	d	L	d	L	d	L	d	L	d
	(cm)	(mm)	(cm)	(mm)	(cm)	(mm)	(cm)	(mm)	(cm)	(mm)	(cm)	(mm)
A	A1		A2		A3		A4		A5		A6	
	5.0	0	5.0	5.0	5.0	7.5	5.0	10.0	5.0	15.0	5.0	20.0
B	B1		B2		B3		B4		B5		B6	
	10.0	0	10.0	5.0	10.0	7.5	10.0	10.0	10.0	15.0	10.0	20.0
C	C1		C2		C3		C4		C5		C6	
	15.0	0	15.0	5.0	15.0	7.5	15.0	10.0	15.0	15.0	15.0	20.0
D	D1		D2		D3		D4		D5		D6	
	20.0	0	20.0	5.0	20.0	7.5	20.0	10.0	20.0	15.0	20.0	20.0
E	E1		E2		E3		E4		E5		E6	
	25.0	0	25.0	5.0	25.0	7.5	25.0	10.0	25.0	15.0	25.0	20.0

Table (2) Sand bed characteristics

Soil type	d_{50}	d_{10}	S. D.*
1	0.478	0.145	1.94
2	0.627	0.456	1.303

* S. D. : standard deviation

Two values of unit discharge ($q = Q/b$) (73.53, and 88.89 $\text{cm}^3/\text{sec}/\text{cm}$) were allowed to recirculate for each type of stilling basin models to study the effect of flow parameters on the formation of the scour hole. At the beginning of every experiment the bed in the test reach was leveled and before each experiment this reach was refilled with sand from the supply container. In order to prevent the formation of local scour at the unsteady flow experimental period, the downstream of the irrigation structure was filled with water to a depth equals the height of the gate opening. It was found that a state of equilibrium for every experimental test could be reached after about 60 minute. At this time, the rate of change in the scour configuration was approximately reached an equilibrium state. The discharge and tail water depth were kept constant through the time period for each test. During each run the discharge was slowly drained. During each run the discharge, and the water surface levels upstream and downstream were measured. At the end of each run, the bed levels along the centerline of the downstream reach were measured.

THEORETICAL ANALYSIS

Scour geometry depends upon various variables, the dimensional analysis, was applied to correlate both the depth and length of the scour hole and the other variables governing the phenomenon of scour downstream water structures. Based on the Buckingham theory, the technique of the dimensional analysis was employed in order to develop the proper correlation, which was needed for defining the scour size. This correlation involved all main variables, which had pronounced effect on the scour hole size (scour depth and scour length as shown in Fig. (3)).

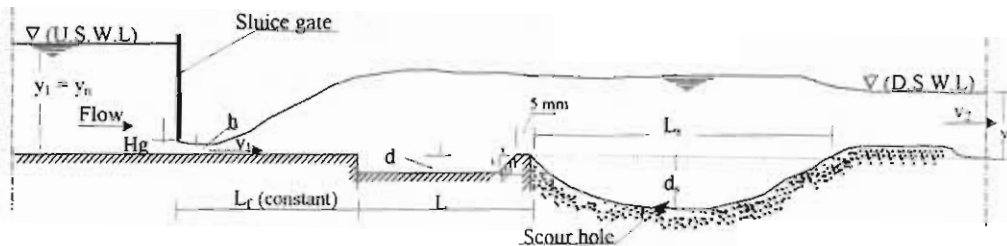

Fig. (3) Definition sketch for the tested model

Equilibrium scour hole was finally developed when the excess kinetic energy could not transport further the sediment particles. Therefore, the dimensions of equilibrium scour hole downstream drop structure can be fairly characterized by its maximum depth d_s , and length L_s . Scour hole geometry depends mainly on the following variables. the depth of flow downstream the drop structure y_2 , the average velocity downstream drop structure v_2 , the gravitational acceleration g , sluice gate opening height H_g , stilling basin length L , stilling basin depth d , the normal upstream water depth y_1 , discharge passing per unit width of channel q , water density ρ , median soil diameter d_{30} , density of particles ρ , dynamic viscosity of water μ , and time of run t .

The scour hole geometry can be expressed as :

$$= f(Hg, L_f, L, d, d_s, L_s, y_1, y_2, q, g, \rho, \mu, t, d_{50}, \rho_s) \quad (1)$$

The value (t) is taken to be constant at the state of equilibrium, and the effect of viscosity (μ) is assumed of a secondary importance in estimating the depth, and the length of scour as the flow is mainly gravitational.

If the maximum equilibrium scour depth (d_s) is taken as a dependent variable, then:

$$d_s = f(Hg, L_f, L, d, L_s, y_1, y_2, q, g, \rho, d_{50}, \rho_s) \quad (2)$$

Applying the Buckingham theory (π - theory) on equation (2), the dimensionless relationship of the maximum scour depth downstream the stilling basin in relation to other parameters could be obtained as follows :

$$d_s / y_2 = f(Hg / y_2, L_f / y_2, L / y_2, d / y_2, L_s / y_2, y_1 / y_2, g y_2^3 / q^2, d_{50} / y_2, \rho_s / \rho) \quad (3)$$

ANALYSIS OF THE RESULTS

In order to obtain adequate relationships among the variables that have an influence upon the scour produced downstream stilling basins, a study of the dimensionless parameters involved was produced.

The experimental data for the relative scour depth d_s / y_2 as a function of d / y_2 at different values of Froude number Fr for different stilling basin lengths L are shown in Fig. (4. a, and 4. b).

In general, it could be observed that, d_s / y_2 increased with the increasing value of Froude number. Also, it was obvious that when d / y_2 increased d_s / y_2 decreases to reach its minimum value at $d / y_2 = 0.17$, and $d / y_2 = 0.15$ for $q = 73.53 \text{ cm}^3 / \text{sec} / \text{cm}$. and $88.89 \text{ cm}^3 / \text{sec} / \text{cm}$ respectively. After that d_s / y_2 increased with minimum values of Fr ranged from 0.26 to 0.36.

For bigger values of stilling basin lengths, the increasing of d / y_2 had small effect on the value of d_s / y_2 for all values of Fr, this value of d_s / y_2 decreased to reach its minimum value at $d / y_2 = 0.20$. and $d / y_2 = 0.25$ for $q = 73.53 \text{ cm}^3 / \text{sec} / \text{cm}$. and $88.89 \text{ cm}^3 / \text{sec} / \text{cm}$ respectively, after that d_s / y_2 was increased with minimum value for all Froude numbers except for Fr = 0.45. For Fr = 0.45 the value of d_s / y_2 was increased with the increasing of d / y_2 , from $d / y_2 = 0.25$ to reach its maximum value at $d / y_2 = 0.45$; after that d_s / y_2 decreased.

Fig. (5. a, and 5. b) demonstrated the relationship between L_s / y_2 and d / y_2 for different stilling basin lengths for $q = 73.53 \text{ cm}^3 / \text{sec} / \text{cm}$, and $88.89 \text{ cm}^3 / \text{sec} / \text{cm}$ respectively. It could be noted that L_s / y_2 was increased with the increasing value of Froude number Fr, also it was evident that, when $d / y_2 = 0.18$, and $d / y_2 = 0.22$ for

$q = 73.53 \text{ cm}^3 / \text{sec} / \text{cm}$, and $88.89 \text{ cm}^3 / \text{sec} / \text{cm}$ respectively, for different values of L . After that L_s / y_2 was increased with the increasing value of d / y_2 to reach its maximum value at $d / y_2 = 0.45$ for $Fr = 0.45$ for all values of the given hypothetical stilling basin lengths. For small values of Froude number the increasing of L_s / y_2 had small effect upon the value of d / y_2 .

Fig. (6) exhibits the relationship between d_s / y_2 , and d / y_2 for the two bed materials. It could be concluded that, increasing the value of d_{50} by about 31% would decrease the dimensions of the scour hole by about 15 % for d_s , and about 5 % for L_s . Fig. (7) provides the relationship between L_s / y_2 and d / y_2 for the two types of bed soil materials; that is the figure demonstrate that the effect of increasing the bed soil diameter d_{50} on the length of the scour hole is small in comparison with its effect on the depth of scour hole about 5%.

The relationship between the values of the relative scour depth d_s / y_2 , and the relative scour length L_s / y_2 is given by the following best fit equation :

$$d_s/y_2 = 0.0884 (L_s/y_2)^{0.9687} \quad (4)$$

which was obtained for Froude number Fr varied between 0.20 and 0.46 and for $d_{50} = 0.478 \text{ mm}$, Fig. (8). In the above equation the correlation coefficient R was equal to 0.91. It could also be seen that when d_s / y_2 was increased, L_s / y_2 increased as well.

From the above analysis, it was clear that, for some stilling basins, the scour hole was unstable. Consequently, Fig. (9) divided the stilling basins into different regions depending on L/y_2 , d/y_2 , and Fr and thus the following observations were obtained:

1. The scour hole was stable for all values above line B, Fig. (9. a), for all values of d/y_2 .
2. For all values of $Fr \leq 0.3499$, and values of L/y_2 below line B the scour hole was stable for all values of d/y_2 .
3. For all values of $Fr \geq 0.3499$, and values of L/y_2 below line A, Fig. (9. a) the scour hole was stable for all values of d/y_2 and the scour hole was stable for values of d/y_2 below line C, Fig. (9. b).

In the present research, the regression analysis technique was used to develop an equation for the local scour based on the functional relationship.

The general formula for the maximum relative scour depth for stable scour hole as a function of different variables was obtained as follows: (Fig. (10))

$$d_s/y_2 = 0.784 - 0.0202L/y_2 - 0.0017d/y_2 - 0.0411/Fr^2 - 0.00052d_{50}/y_2 + 0.00815Hg/y_2 + 0.00942ly_1/y_2 \quad (5)$$

Also, the following equation was obtained from the regressed data for the maximum relative scour length (Fig. (11)):

$$L_s/y_2 = 10.1663 - 0.315L/y_2 - 1.916d/y_2 - 0.4773/Fr^2 + 0.00102d_{50}/y_2 - 0.000935Hg/y_2 + 0.0173y_1/y_2 \quad (6)$$

CONCLUSIONS

The main conclusions of this experimental study on the local scour downstream irrigation structures could be stated as follows:

1. The use of stilling basins reduced the dimensions of the scour hole.
2. The scouring process was affected by Froude number downstream the stilling basin. Both relative scour depth d_s / y_2 , and relative scour length L_s / y_2 were increased with the increasing value of Froude number.
3. The particle diameter of the bed material had an influence upon the scour process, i. e., the smaller particle diameter, the larger scour hole dimensions.
4. The maximum scour length was relatively proportional to the maximum scour depth as derived in Eqn. (4)
5. In some cases of the flow conditions and for certain stilling basin dimensions, the scour hole was unstable depending on the value of L/y_2 , d/y_2 , and Fr . Using Fig. (9), the dimensions of the stilling basin which gave stable scour hole could be obtained as a function of Fr .
6. The general, two empirical equations were developed by regression analysis for stable scour hole. The equations were derived for different dimensions of stilling basin models with different flow conditions and certain specified bed material properties. (Eqn. (5), and Eqn. (6)).

REFERENCES

- 1- Baghdadi, K. H. (1997), "Local scour downstream drop structure.", Alexandria Engineering Journal, Vol. 36, No. 2, March 1997.
- 2- Bureau of Reclamation (1964), "Hydraulic design of stilling basins and bucket energy dissipators." Engineering Monograph No. 25.
- 3- Catakli, O. et al. (1973), "A study of scour at the end of stilling basin and use of horizontal beams as energy dissipators." 11th Congress of Large Dams, Madrid.
- 4- El Abd S. M. (2002), "Effect of using stilling basins on local scour downstream irrigation structures." M. Sc. Thesis, Irrigation and Hydraulic Dept. El-Mansoura University, Egypt. (Unpublished, presented for discussion)
- 5- El-Gamal, M. M. (1991), "Behavior of hydraulic jump on a stilling basins." Journal (MEJ) Vol. 16, No. 1.

- 6- Hoffmans, G. J. C. M. (1998), "Jet scour in equilibrium phase." Journal of Hydraulic Engineering, ASCE, Vol. 124 No. HY 4, PP 430 – 437.
- 7- Novak, P. J. (1961), "Influence of bed load passage on scour and turbulence downstream of stilling basin." 9th Congress, IAHR, Dubrovnik.
- 8- Peterka, A. J. (1984), "Hydraulic design of stilling basins and energy dissipators." Engineering Monograph No. 25, U.S. Dept. of the Interior, Bureau of Reclamation.
- 9- Pillai, N. N., and et al (1989), "Hydraulic jump type stilling basin for low Froude numbers." Journal of Hydraulic Engineering, ASCE, Vol. 115 No. HY 7, PP 989 – 994.
- 10- Rice, C. E., and Kadavy, K. C (1993), "Protection against scour at SAF stilling basins." Journal of Hydraulic Engineering, ASCE, Vol. 119 No. HY 1, PP 133 – 139.
- 11- Uymaz, A. (1988), "The investigation of the scours originating when water passes simultaneously over and under vertical gates." Journal of Hydraulic Engineering, ASCE, Vol. 114 No. HY 7, PP 811 – 816.

NOTATION

The following symbols were used in this paper:

- d : depth of the stilling basin;
- d_n : particle size for which n % of the material finer in mm;
- d_s : depth of scour hole;
- Fr : subcritical Froude number at y_2 ;
- g : acceleration due to gravity;
- h : supercritical depth at the toe of the hydraulic jump;
- Hg : sluice gate opening height;
- L : length of the stilling basin;
- L_f : flat length of apron (constant);
- L_s : length of the scour hole;
- Q : discharge;
- q : discharge per unit width;
- v_2 : downstream velocity at y_2 ;
- y_1 : upstream water depth equal to y_n ;
- y_2 : downstream water depth;
- μ : dynamic viscosity of water;
- ρ : density of water; and
- ρ_s : density of particles.

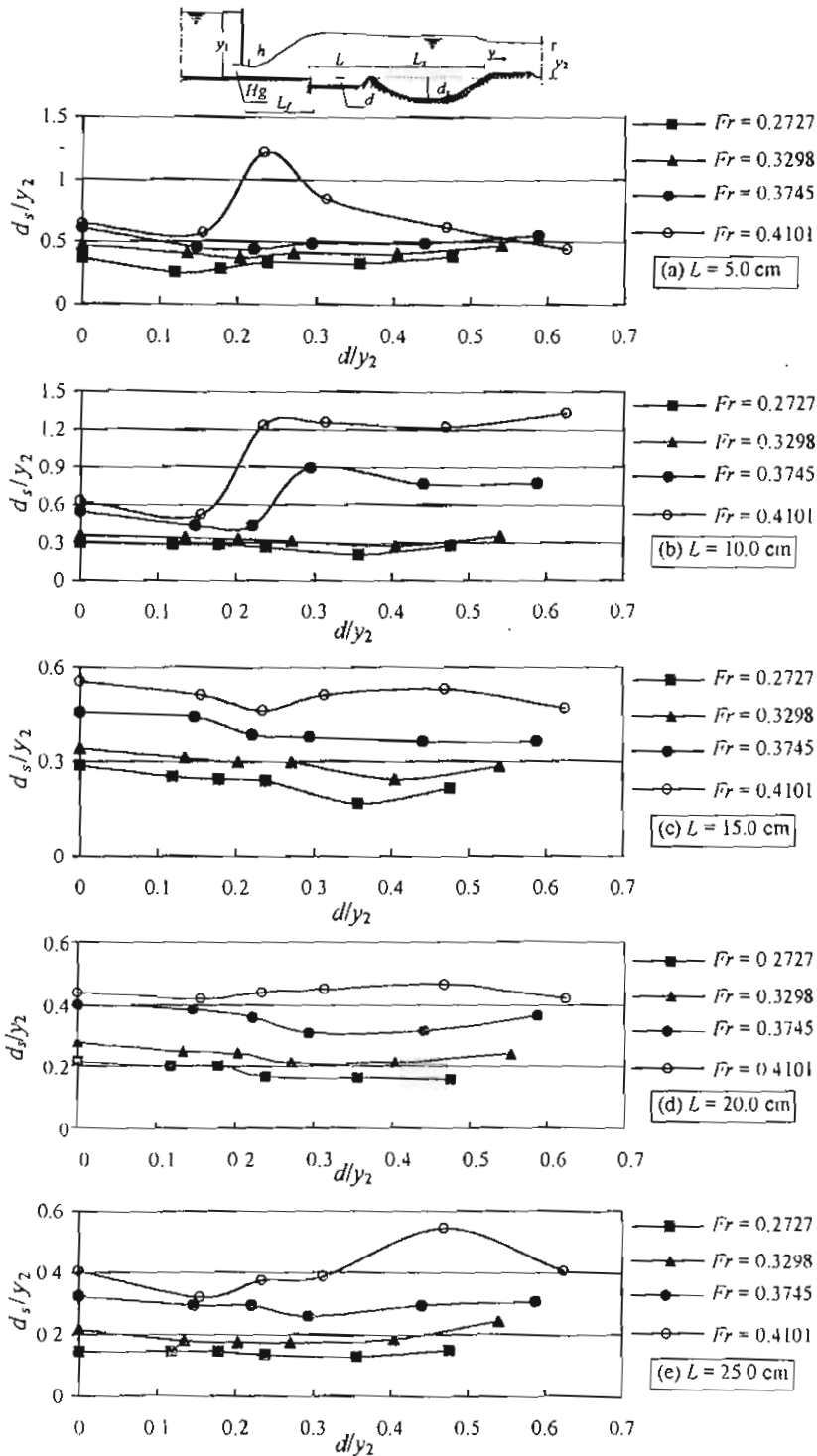

Fig. (4. a) Relationship between relative scour depth d_s/y_2 and relative stilling basin depth d/y_2 for various stilling basin lengths L , at different values of Froude numbers Fr . ($q = 73.53 \text{ cm}^3/\text{sec}/\text{cm}$)

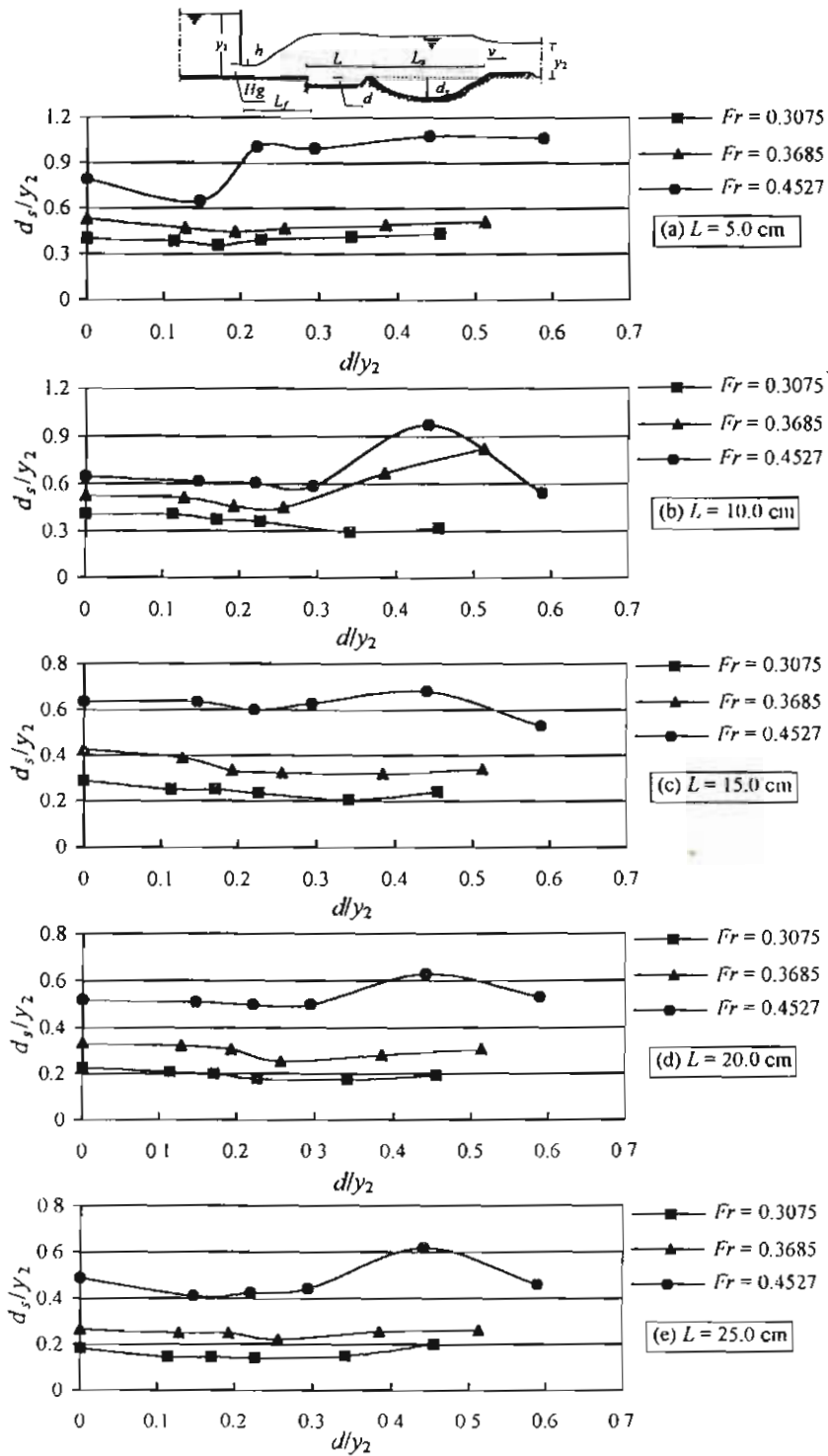

Fig. (4. b) Relationship between relative scour depth d_s/y_2 and relative stilling basin depth d/y_2 for various stilling basin lengths L , at different values of Froude numbers Fr . ($q = 88.89 \text{ cm}^3/\text{sec}/\text{cm}$)

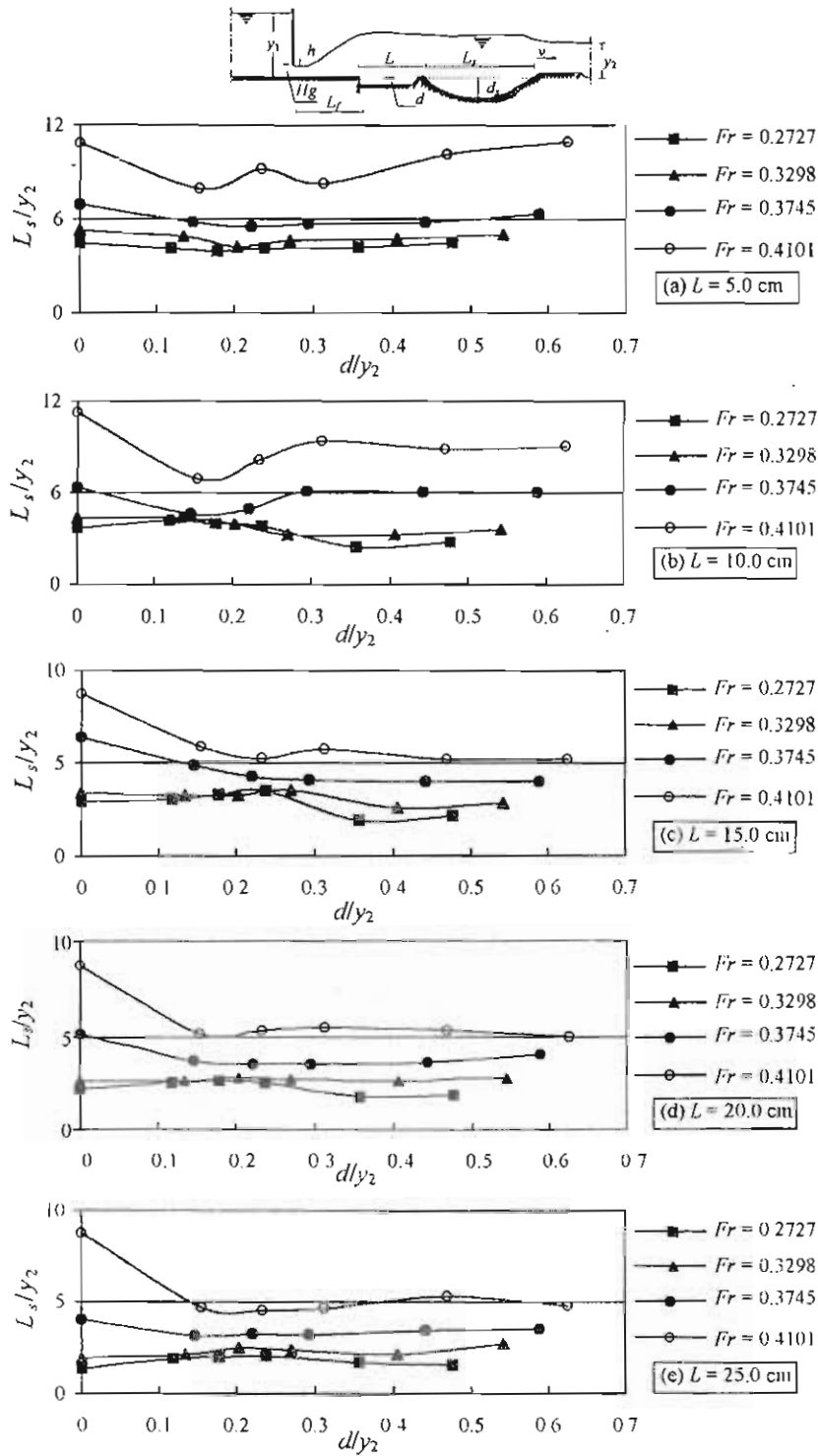

Fig. (5. a) Relationship between relative scour length L_s/y_2 and relative stilling basin depth d/y_2 for various stilling basin lengths L , at different values of Froude numbers Fr . ($q = 73.53 \text{ cm}^3/\text{sec}/\text{cm}$)

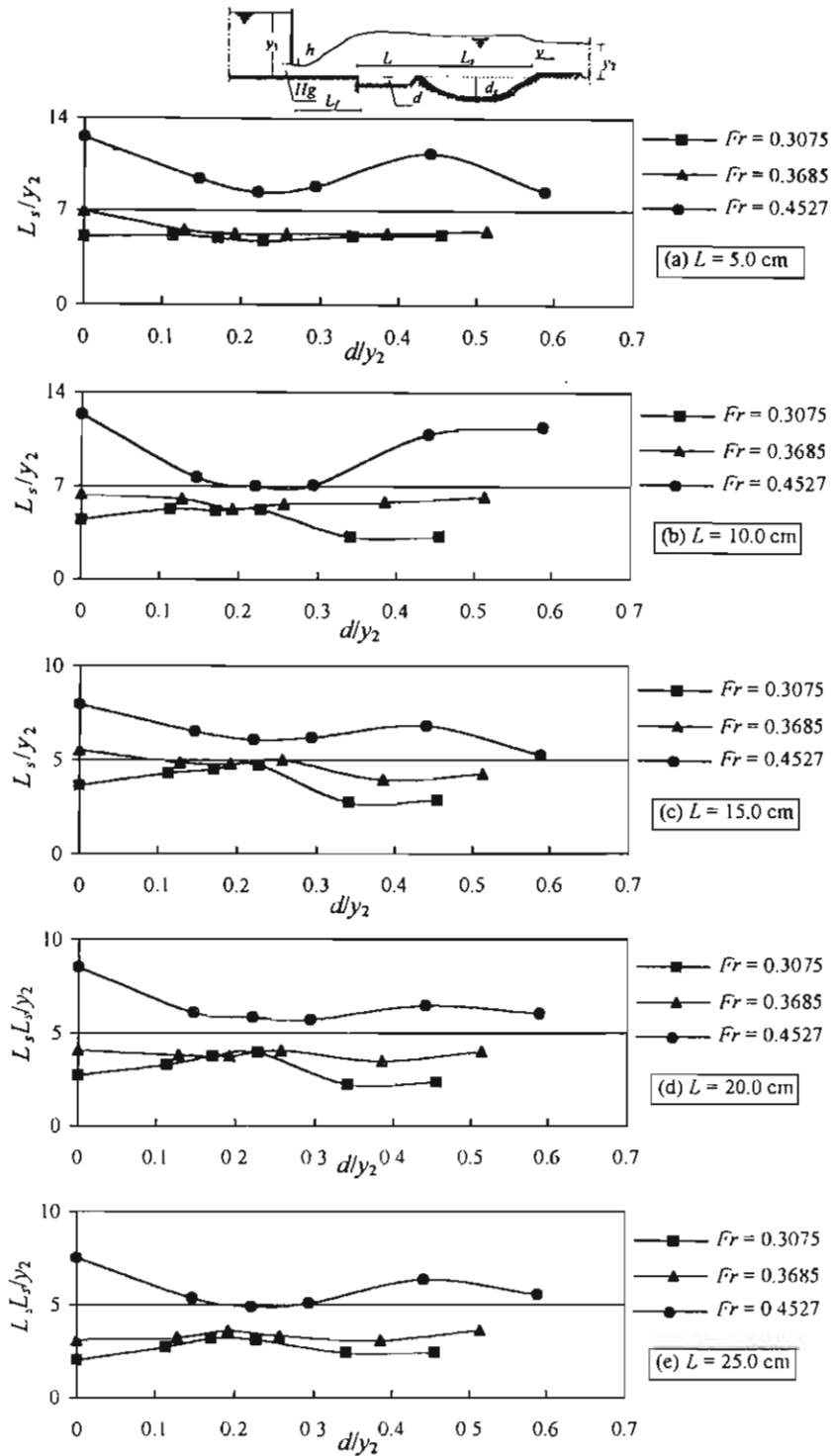
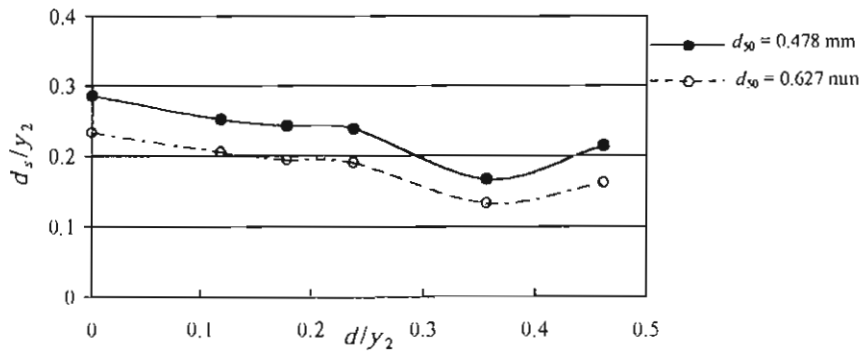
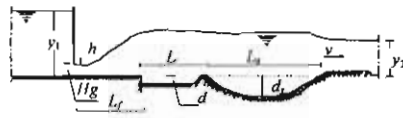
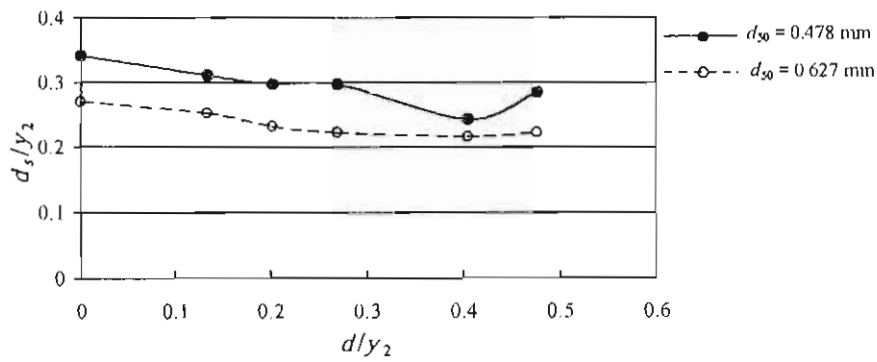

Fig. 5. b) Relationship between relative scour length L_s/y_2 and relative stilling basin depth d/y_2 for various stilling basin lengths L , at different values of Froude numbers Fr . ($q = 88.89 \text{ cm}^3/\text{sec}/\text{cm}$)



(a) $Fr = 0.2727$, and $L/y_2 = 3.5714$.



(b) $Fr = 0.3298$, and $L/y_2 = 4.0541$.

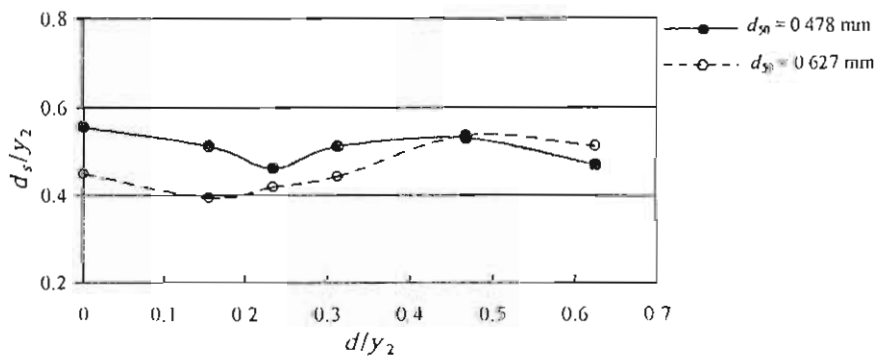

(c) $Fr = 0.4101$, and $L/y_2 = 4.6875$.

Fig. (6) Variation of d_s/y_2 with d/y_2 for the two bed soil diameters at different values of Fr , and L/y_2 ($q = 73.53 \text{ cm}^3/\text{sec}/\text{cm}$).

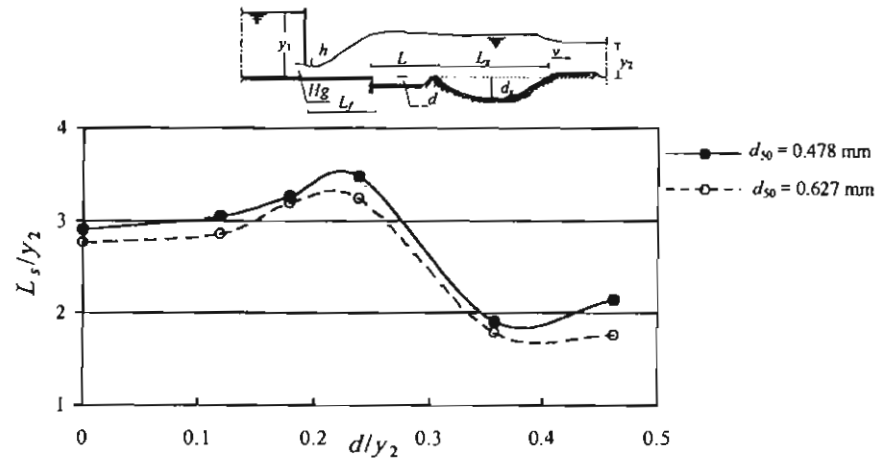

(a) $Fr = 0.2727$, and $L/y_2 = 3.5714$.

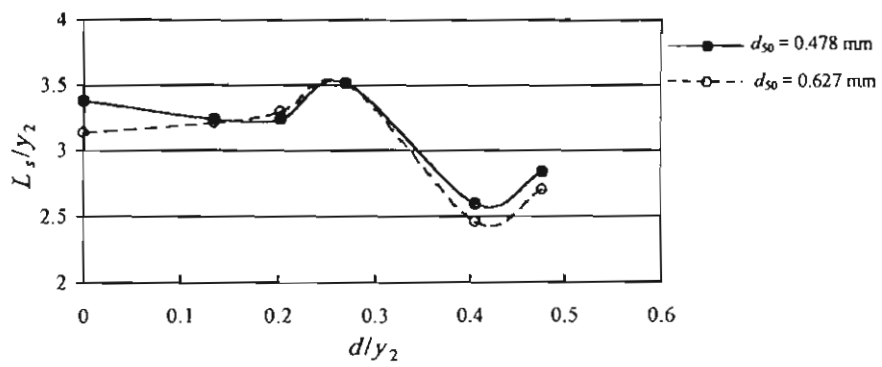

(b) $Fr = 0.3298$, and $L/y_2 = 4.0541$.

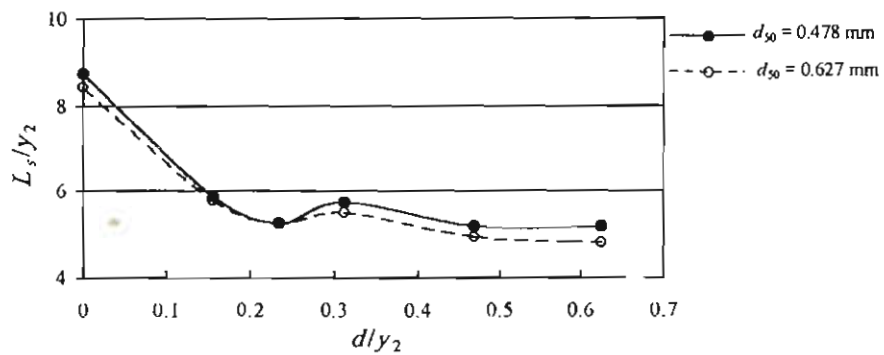

(c) $Fr = 0.4101$, and $L/y_2 = 4.6875$.

Fig. (7) Variation of L_s/y_2 with d/y_2 for the two bed soil diameters at different values of Fr , and L/y_2 .
($q = 73.53 \text{ cm}^3/\text{sec}/\text{cm}$)

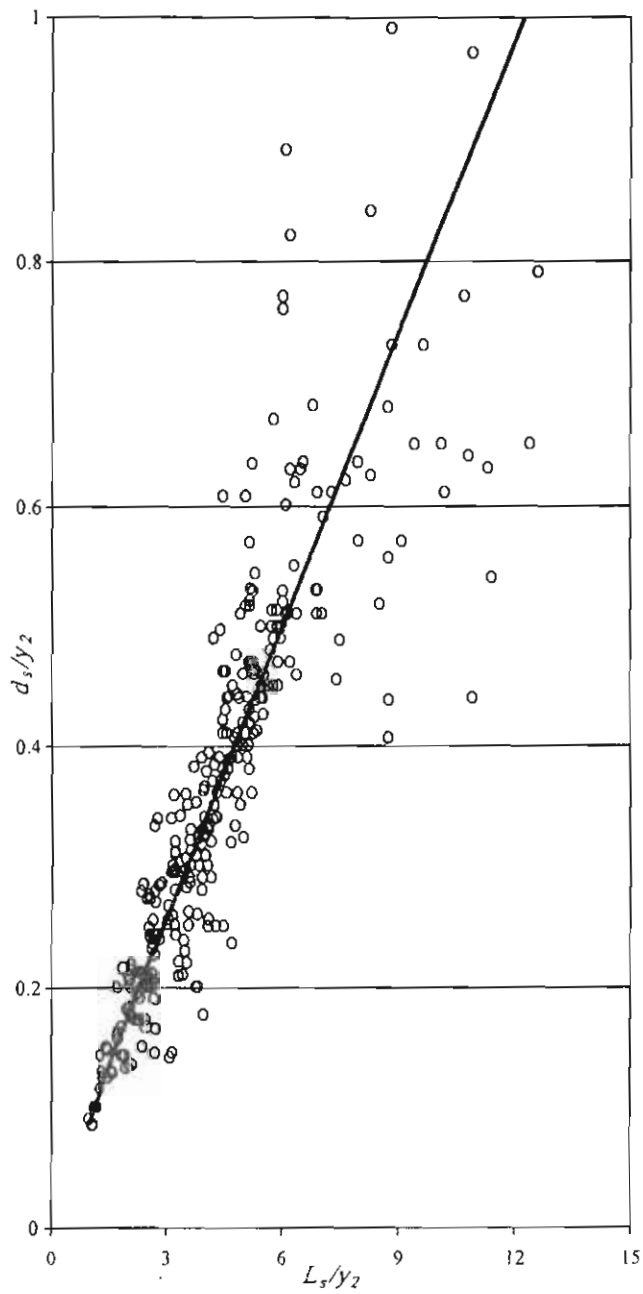

Fig. (8) Relationship between d_s/y_2 and L_s/y_2 for all types of stilling basins.

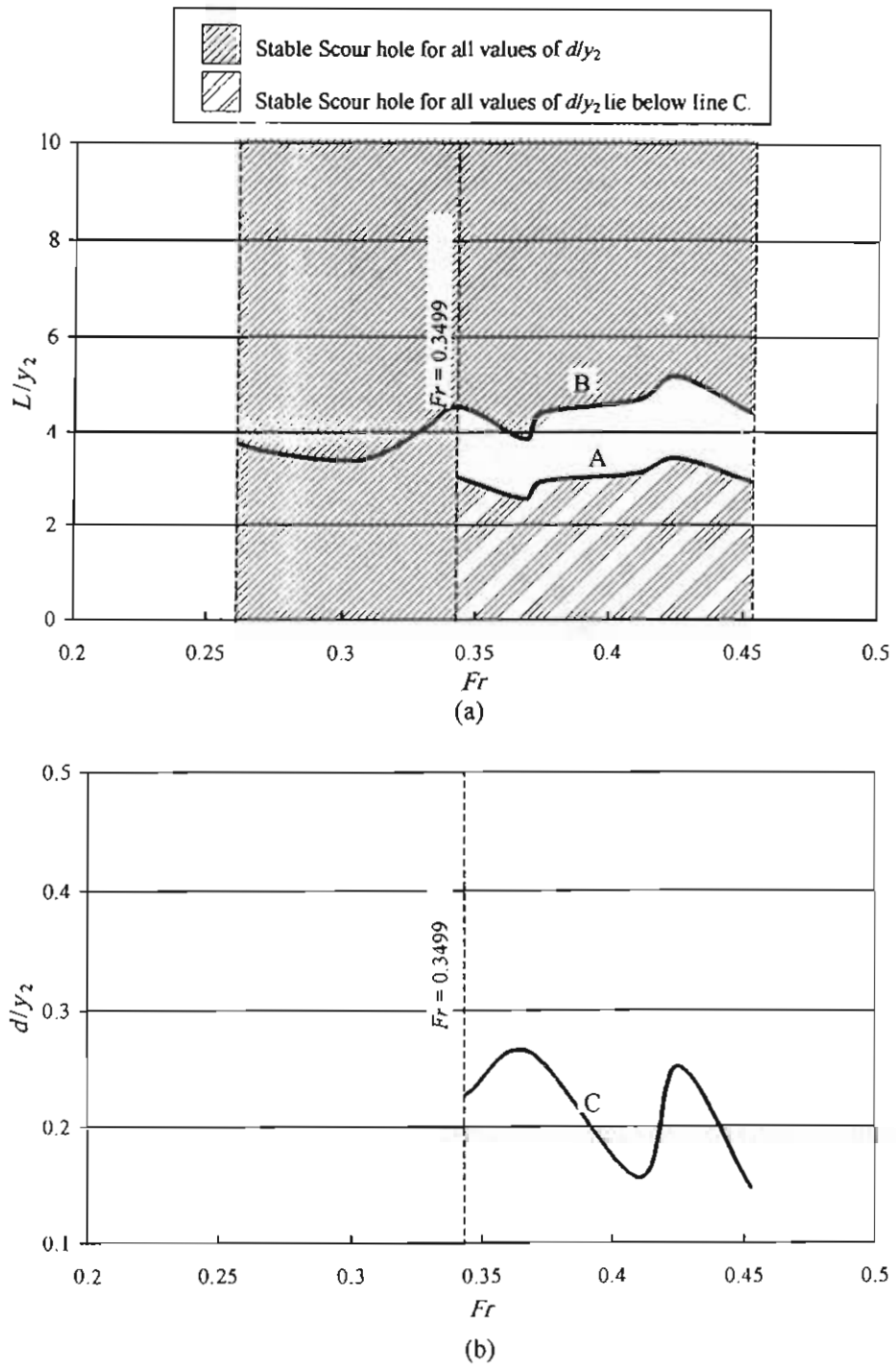

Fig. (9) Variation of Fr with L/y_2 , and d/y_2

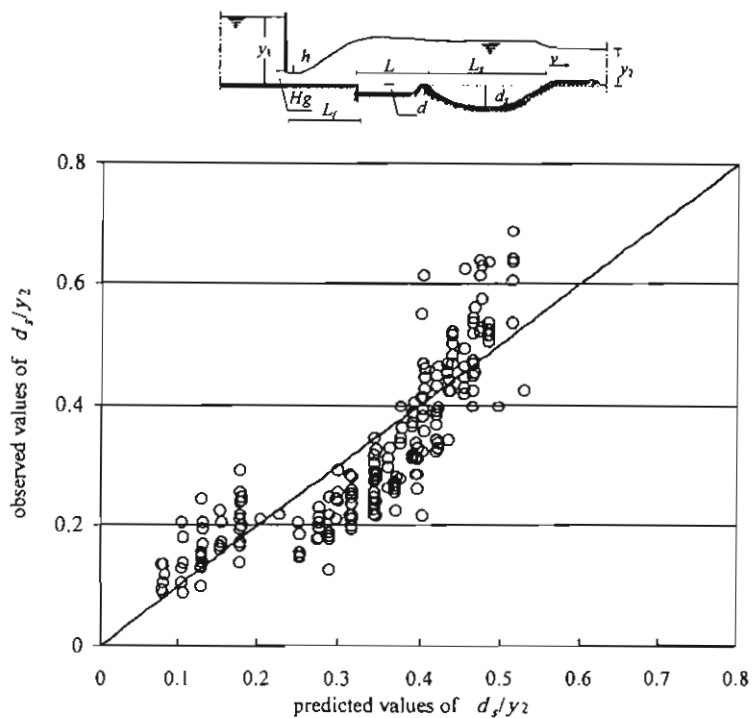

Fig. (10) Relationship between observed values of d_s/y_2 and predicted ones.

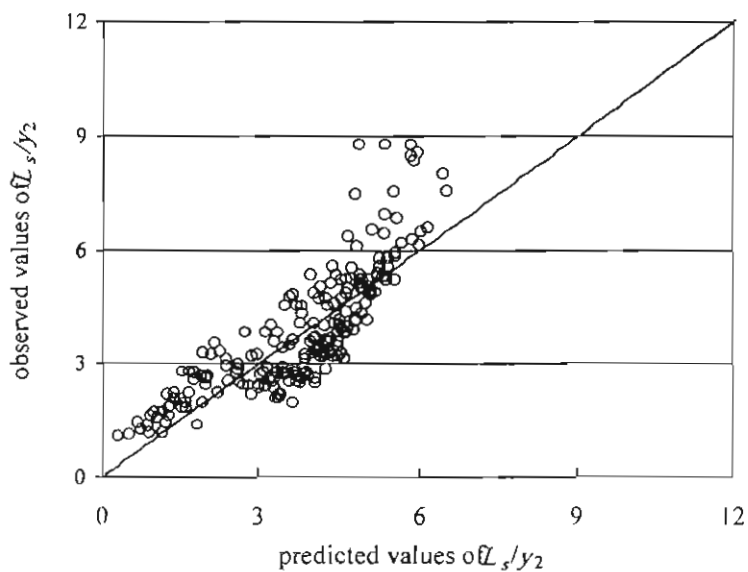

Fig. (11) Relationship between observed values of L_s/y_2 and predicted ones.